

Analog Devices Welcomes Hittite Microwave Corporation

NO CONTENT ON THE ATTACHED DOCUMENT HAS CHANGED



THIS PAGE INTENTIONALLY LEFT BLANK

Typical Applications

The HMC725LC3C is ideal for:

- 16 G Fiber Channel
- RF ATE Applications
- Broadband Test & Measurement
- Serial Data Transmission up to 14 Gbps
- Digital Logic Systems up to 14 GHz

Features

- Inputs Terminated Internally to 50 Ohms
- Differential or Single-Ended Operation
- Fast Rise and Fall Times: 19 / 18 ps
- Low Power Consumption: 230 mW typ.
- Propagation Delay: 105 ps
- Single Supply: -3.3 V
- 16 Lead Ceramic 3x3 mm SMT Package: 9 mm²

Functional Diagram

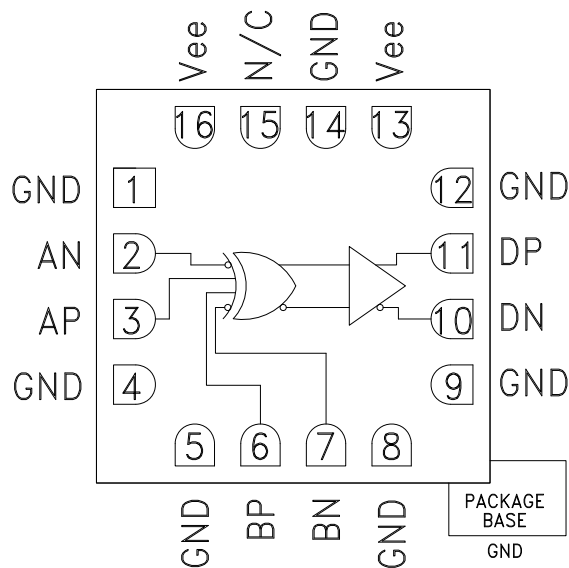

General Description

The HMC725LC3C is a XOR/XNOR gate function designed to support data transmission rates of up to 14 Gbps, and clock frequencies as high as 14 GHz.

All differential inputs to the HMC725LC3C are CML and terminated on-chip with 50 Ohms to the positive supply, GND, and may be DC or AC coupled. The differential CML outputs are source terminated to 50 Ohms and may also be AC or DC coupled. Outputs can be connected directly to a 50 Ohm ground-terminated system or drive devices with CML logic input. The HMC725LC3C operates from a single -3.3 V supply and is available in ROHS-compliant 3x3 mm SMT package.

Electrical Specifications, $T_A = +25\text{ }^\circ\text{C}$, $V_{ee} = -3.3\text{ V}$

Parameter	Conditions	Min.	Typ.	Max	Units
Power Supply Voltage		-3.6	-3.3	-3.0	V
Power Supply Current			70		mA
Maximum Data Rate			14		Gbps
Maximum Clock Rate			14		GHz
Input Voltage Range		-1.5		0.5	V
Input Differential Range		0.1		2.0	Vp-p
Input Return Loss	Frequency <14 GHz		10		dB
Output Amplitude	Single-Ended, peak-to-peak		550		mVp-p
	Differential, peak-to-peak		1100		mVp-p
Output High Voltage			-10		mV
Output Low Voltage			-560		mV
Output Rise / Fall Time	Differential, 20% - 80%		19 / 18		ps

For price, delivery and to place orders: Hittite Microwave Corporation, 2 Elizabeth Drive, Chelmsford, MA 01824

Phone: 978-250-3343 Fax: 978-250-3373 Order On-line at www.hittite.com

Application Support: Phone: 978-250-3343 or apps@hittite.com



Electrical Specifications (continued)

Parameter	Conditions	Min.	Typ.	Max.	Units
Output Return Loss	Frequency <14 GHz		10		dB
Small Signal Gain			27		dB
Random Jitter Jr	rms			0.2	ps rms
Deterministic Jitter, Jd	peak-to-peak, 2 ¹⁵ -1 PRBS input [1]		2		ps, p-p
Propagation Delay, td			105		ps

[1] Deterministic jitter calculated by simultaneously measuring the jitter of a 300 mV, 13 GHz, 2¹⁵-1 PRBS input, and a single-ended output

DC Current vs. Supply Voltage [1]

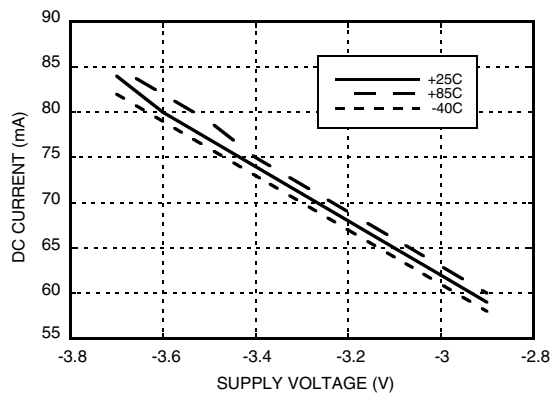

Output Differential Voltage vs. Supply Voltage [2]

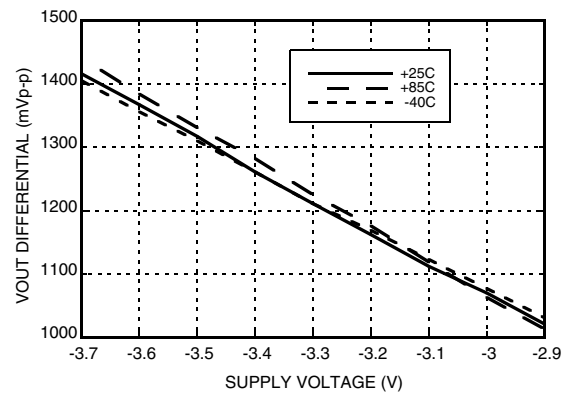

Output Differential Voltage vs. Frequency [3]

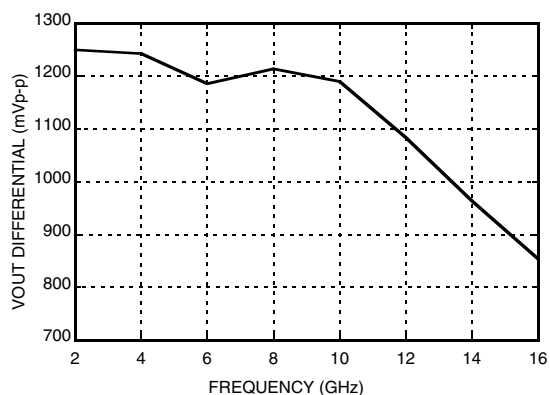

Rise / Fall Time vs. Supply [1]

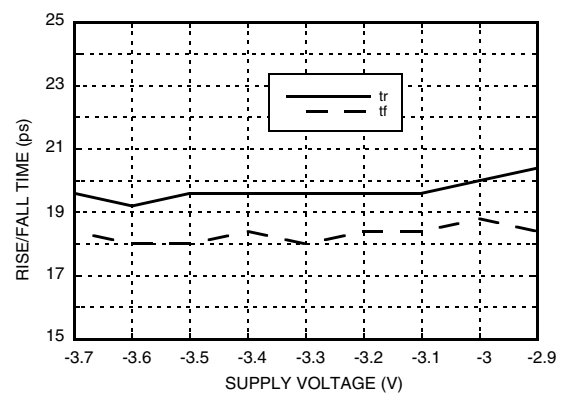

[1] Data rate = 13 Gbps

[2] Frequency = 10 GHz

[3] Vee = -3.3 V

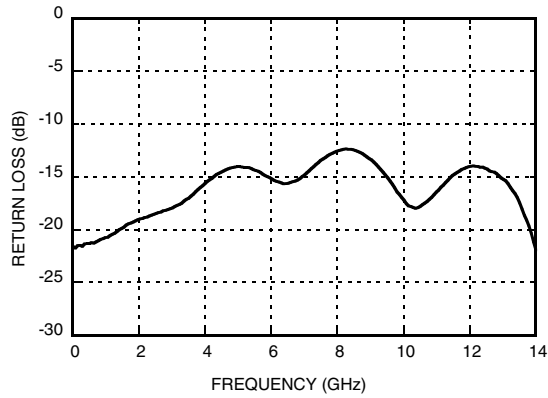
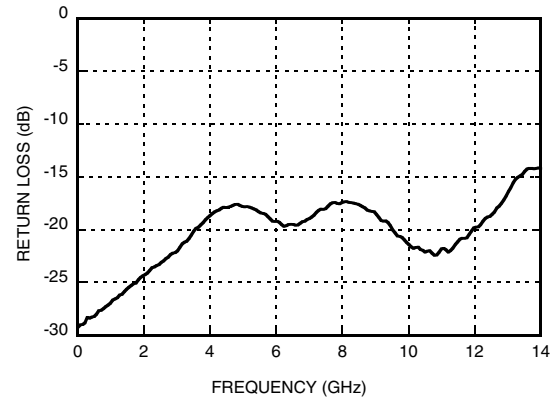
**Output Return Loss vs. Frequency****Input Return Loss vs. Frequency**

Eye Diagram

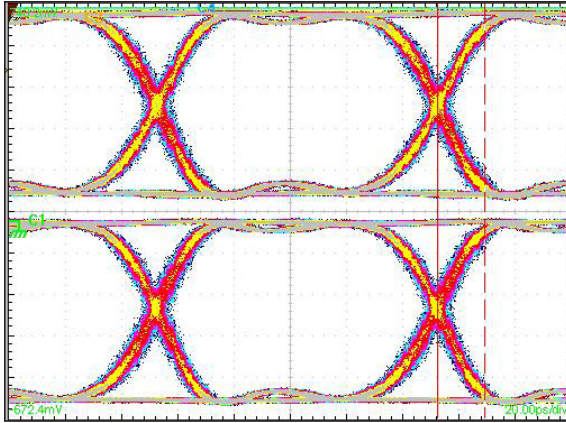

[1] Test Conditions:
 Pattern generated with an Agilent N4903A Serial BERT.
 Eye Diagram presented on a Tektronix CSA 8000.
 Device input = 10 Gbps PN code, $V_{in} = 300$ mVp-p differential.
 Both output channels shown.

Timing Diagram

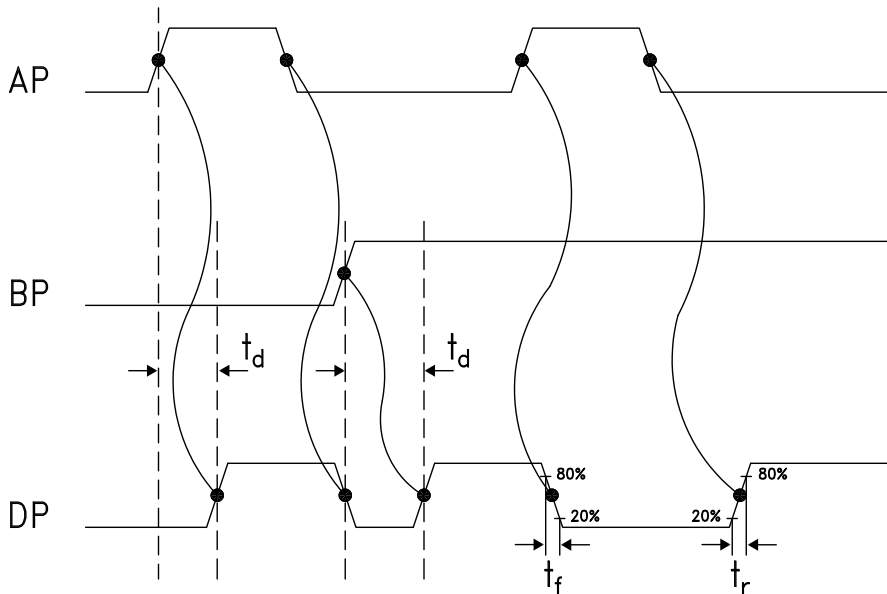

Truth Table

Input		Outputs
A	B	D
L	L	L
L	H	H
H	L	H
H	H	L

Notes:
 A = AP - AN
 B = BP - BN
 D = DP - DN

H - Positive voltage level
 L - Negative voltage level

Absolute Maximum Ratings

Power Supply Voltage (Vee)	-3.75 V to +0.5 V
Input Signals	-2 V to +0.5 V
Output Signals	-1.5 V to +1 V
Continuous Pdiss (T = 85 °C) (derate 17 mW/°C above 85 °C)	0.68 W
Thermal Resistance (R _{th j-p}) Worst case junction to package paddle	59 °C/W
Maximum Junction Temperature	125 °C
Storage Temperature	-65 °C to +150 °C
Operating Temperature	-40 °C to +85 °C
ESD Sensitivity (HBM)	Class 1C

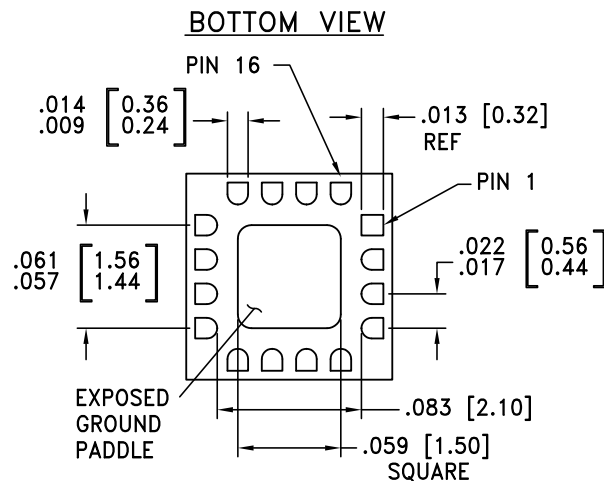
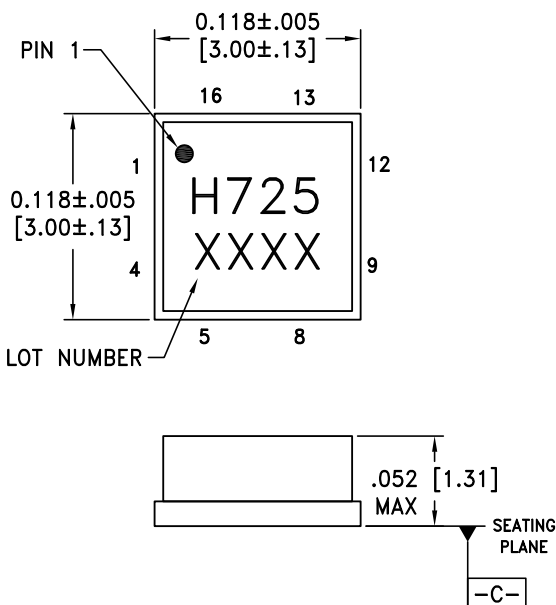
**ELECTROSTATIC SENSITIVE DEVICE
OBSERVE HANDLING PRECAUTIONS**
Outline Drawing

NOTES:

1. PACKAGE BODY MATERIAL: ALUMINA
2. LEAD AND GROUND PADDLE PLATING:
30-80 MICROINCHES GOLD OVER 50 MICROINCHES MINIMUM NICKEL.
3. DIMENSIONS ARE IN INCHES [MILLIMETERS].
4. LEAD SPACING TOLERANCE IS NON-CUMULATIVE.
5. PACKAGE WARP SHALL NOT EXCEED 0.05 mm DATUM -C-
6. ALL GROUND LEADS MUST BE SOLDERED TO PCB RF GROUND.
7. PADDLE MUST BE SOLDERED TO GND.

Package Information



Part Number	Package Body Material	Lead Finish	MSL Rating	Package Marking ^[2]
HMC725LC3C	Alumina, White	Gold over Nickel	MSL3 ^[1]	H725 XXXX

[1] Max peak reflow temperature of 260 °C

[2] 4-Digit lot number XXXX

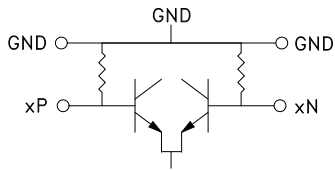
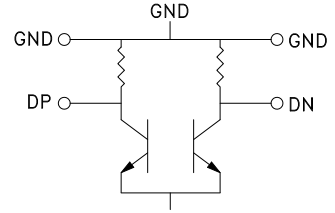

Pin Descriptions

Pin Number	Function	Description	Interface Schematic
1, 4, 5, 8, 9, 12	GND	These pins must be connected to a high-quality RF/DC ground.	
2, 3 6, 7	AN, AP BP, BN	Differential Data Inputs, Current Mode Logic (CML) referenced to positive supply.	
10, 11	DN, DP	Differential Data Outputs, Current Mode Logic (CML) referenced to positive supply	
13, 16	Vee	Negative Supply	
14, Package Base	GND	Supply Ground	
15	N/C	No Connection required. This pin may be connected to RF/DC ground without affecting performance.	

Evaluation PCB

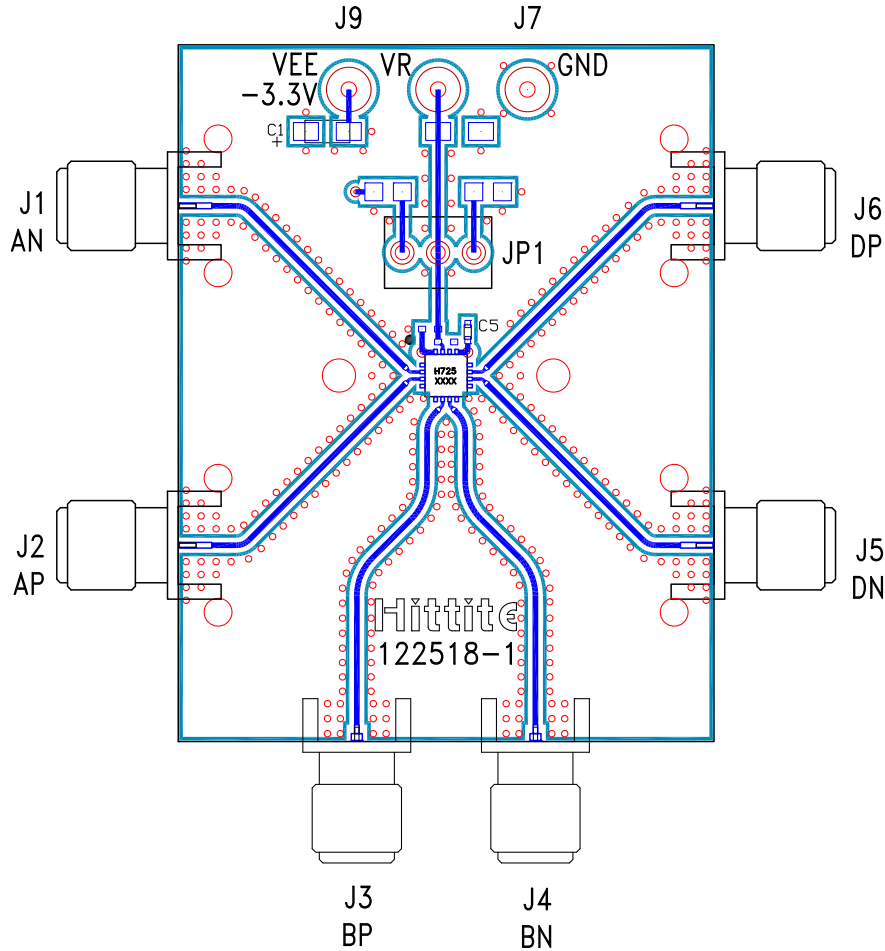

List of Materials for Evaluation PCB 122520 [1]

Item	Description
J1 - J6	PCB Mount SMA RF Connectors
J7, J9	DC Pin
C1	4.7 μ F Capacitor, Tantalum
C5	100 pF Capacitor, 0402 Pkg.
U1	HMC725LC3C High Speed Logic, XOR / XNOR
PCB [2]	122518 Evaluation Board

[1] Reference this number when ordering complete evaluation PCB

[2] Circuit Board Material: Arlon 25FR or Rogers 4350

The circuit board used in the application should use RF circuit design techniques. Signal lines should have 50 Ohm impedance while the package ground leads should be connected directly to the ground plane similar to that shown. The exposed package base should be connected to GND. A sufficient number of via holes should be used to connect the top and bottom ground planes. The evaluation circuit board shown is available from Hittite upon request.

Application Circuit